

# ESW – 108CKR

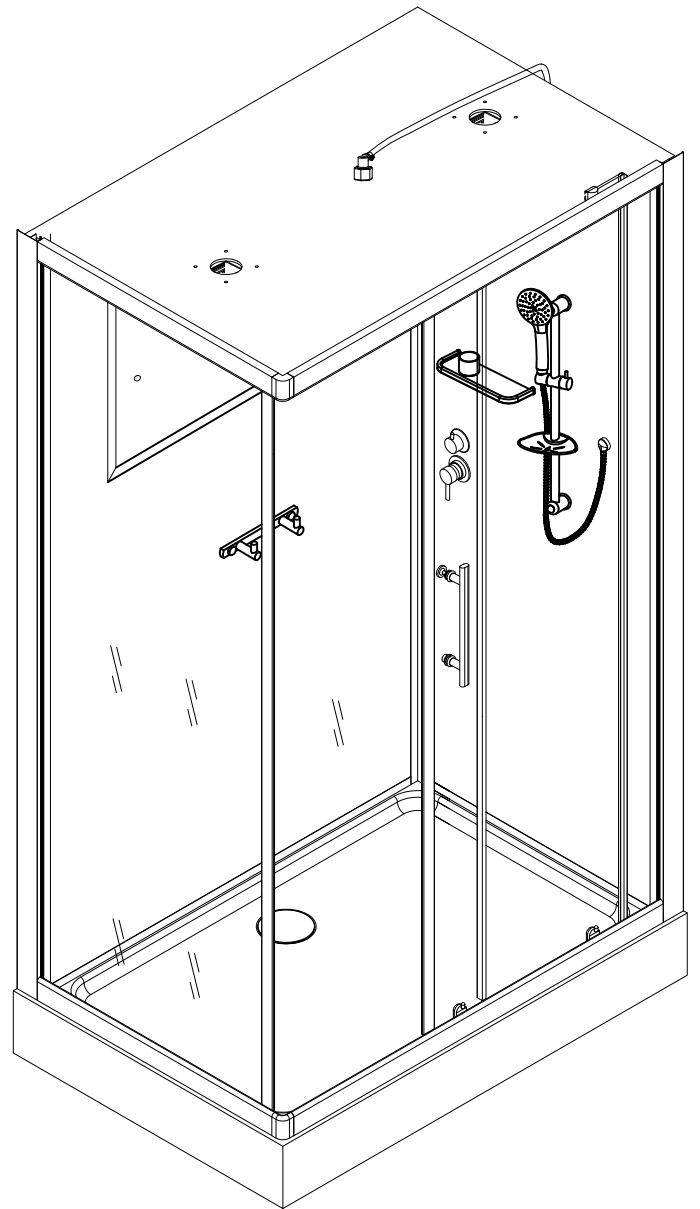

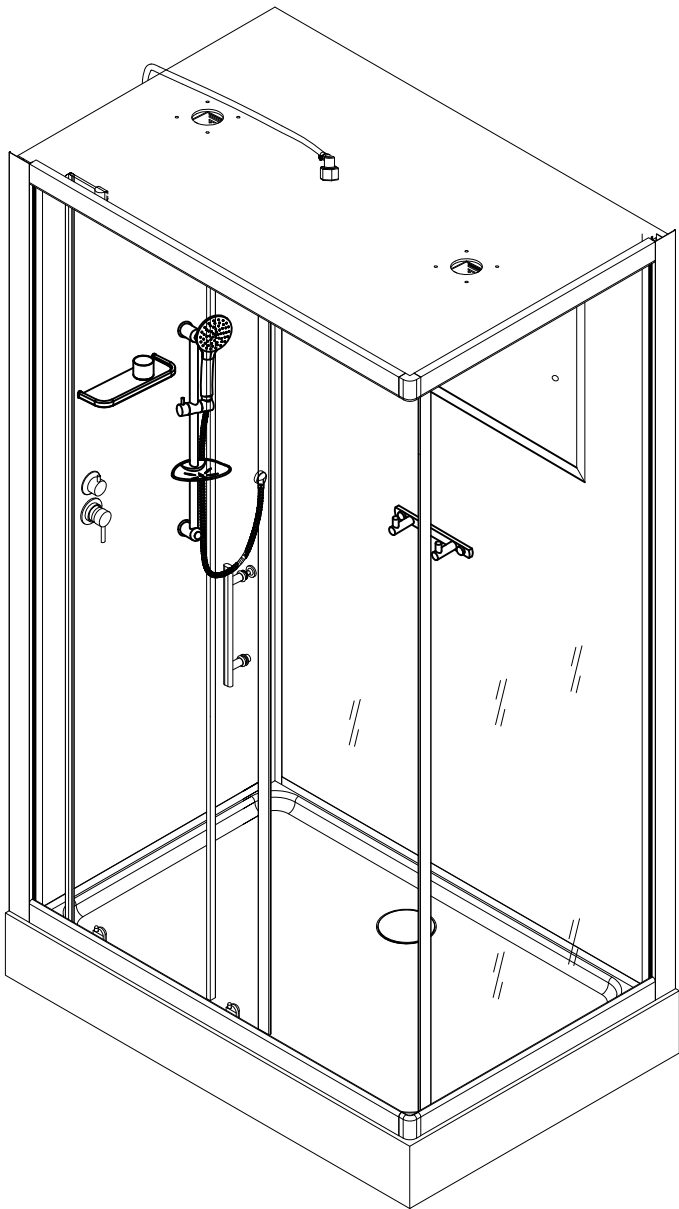

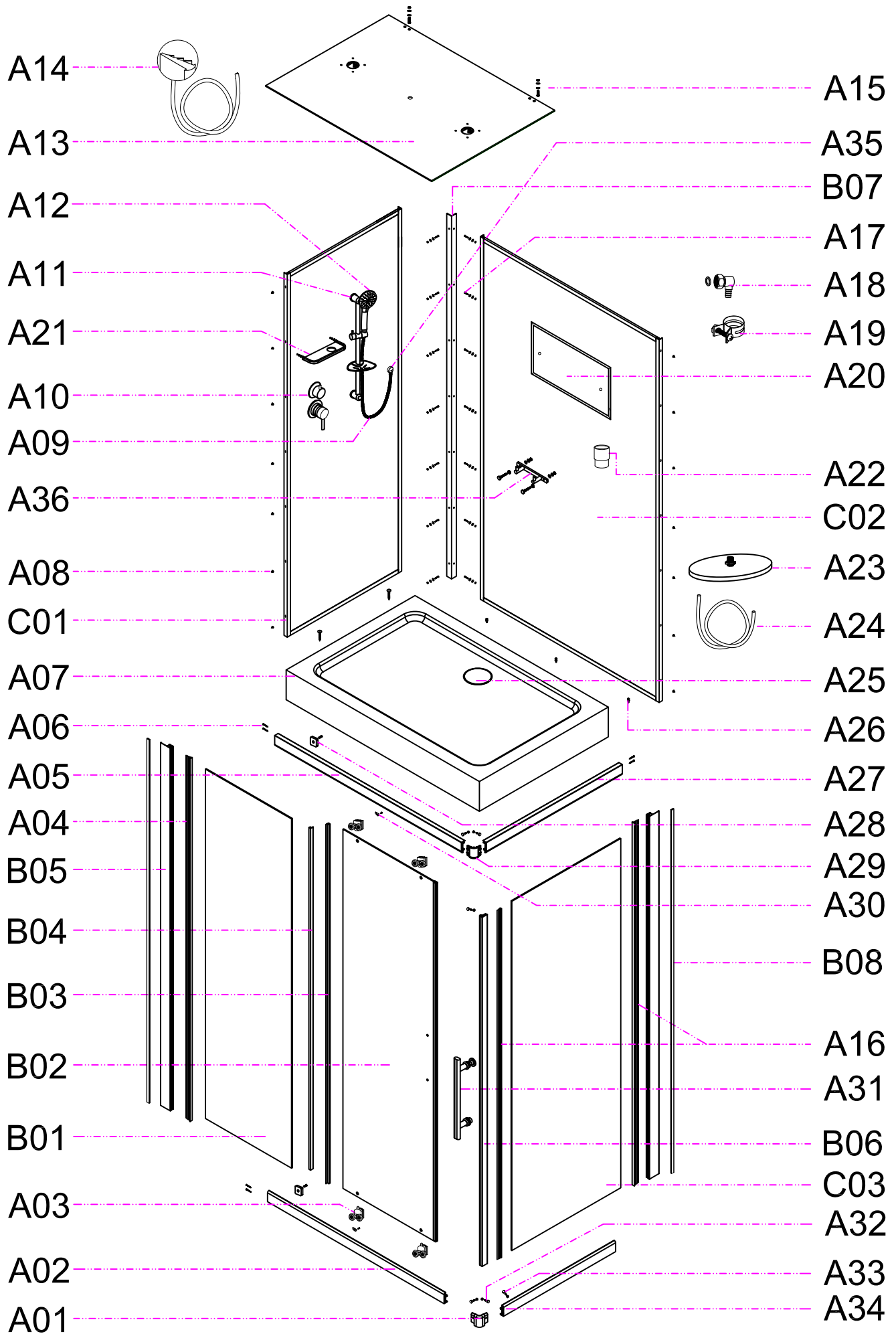

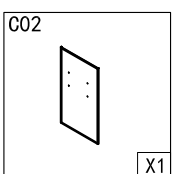
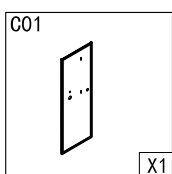
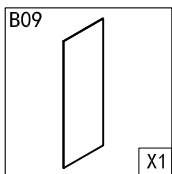
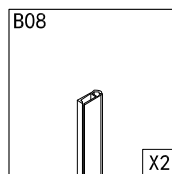
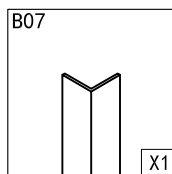
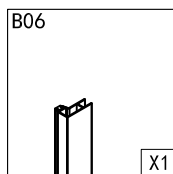
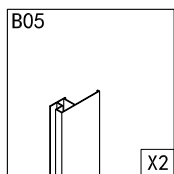
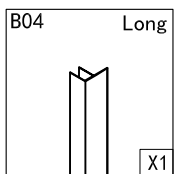
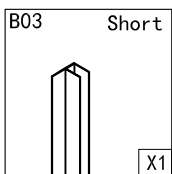
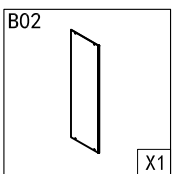
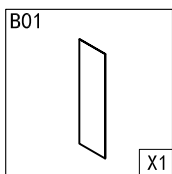
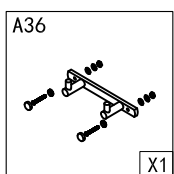
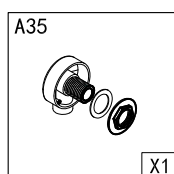
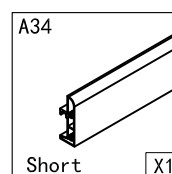
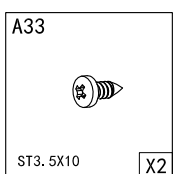
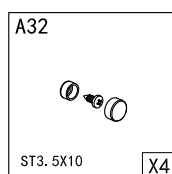
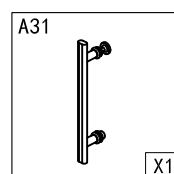
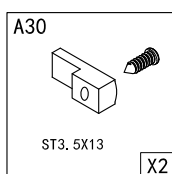
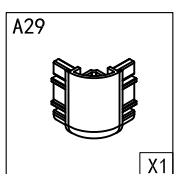
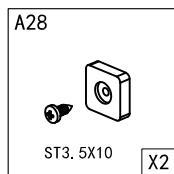
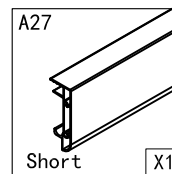
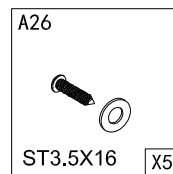
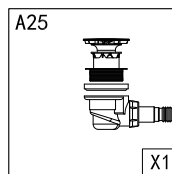
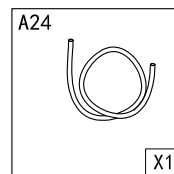
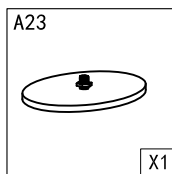
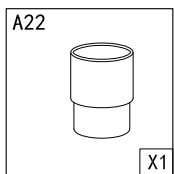
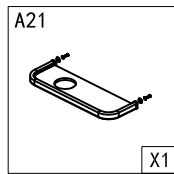
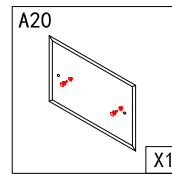
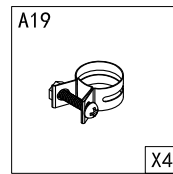
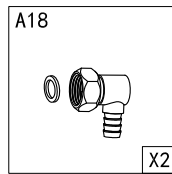
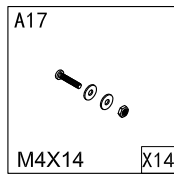
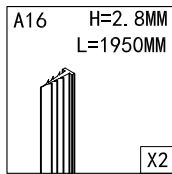
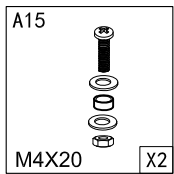
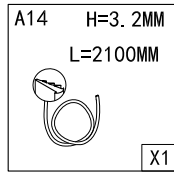
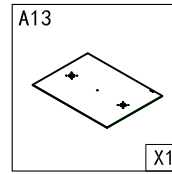
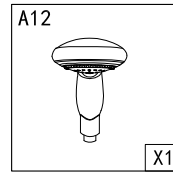
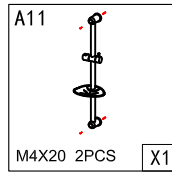
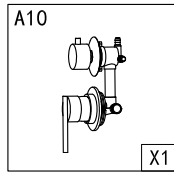
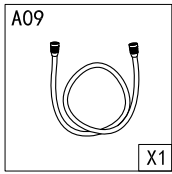
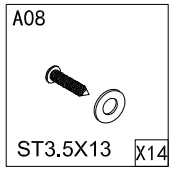
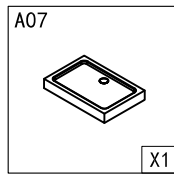
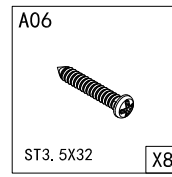
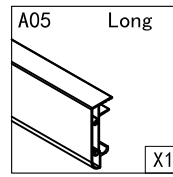
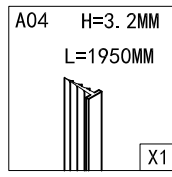
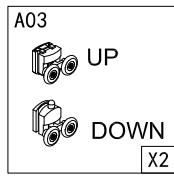
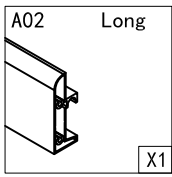
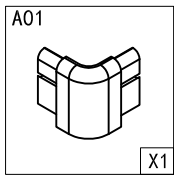
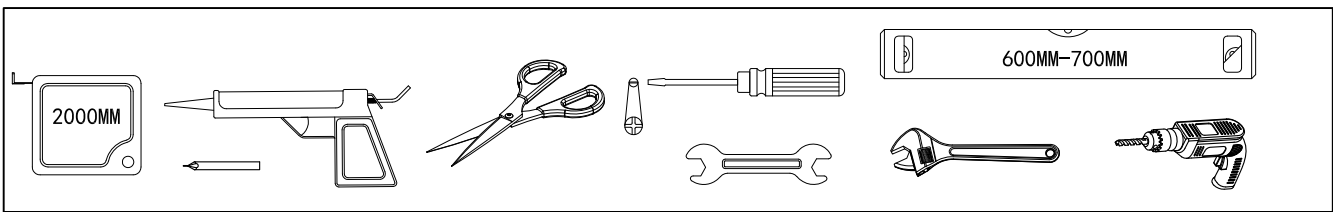
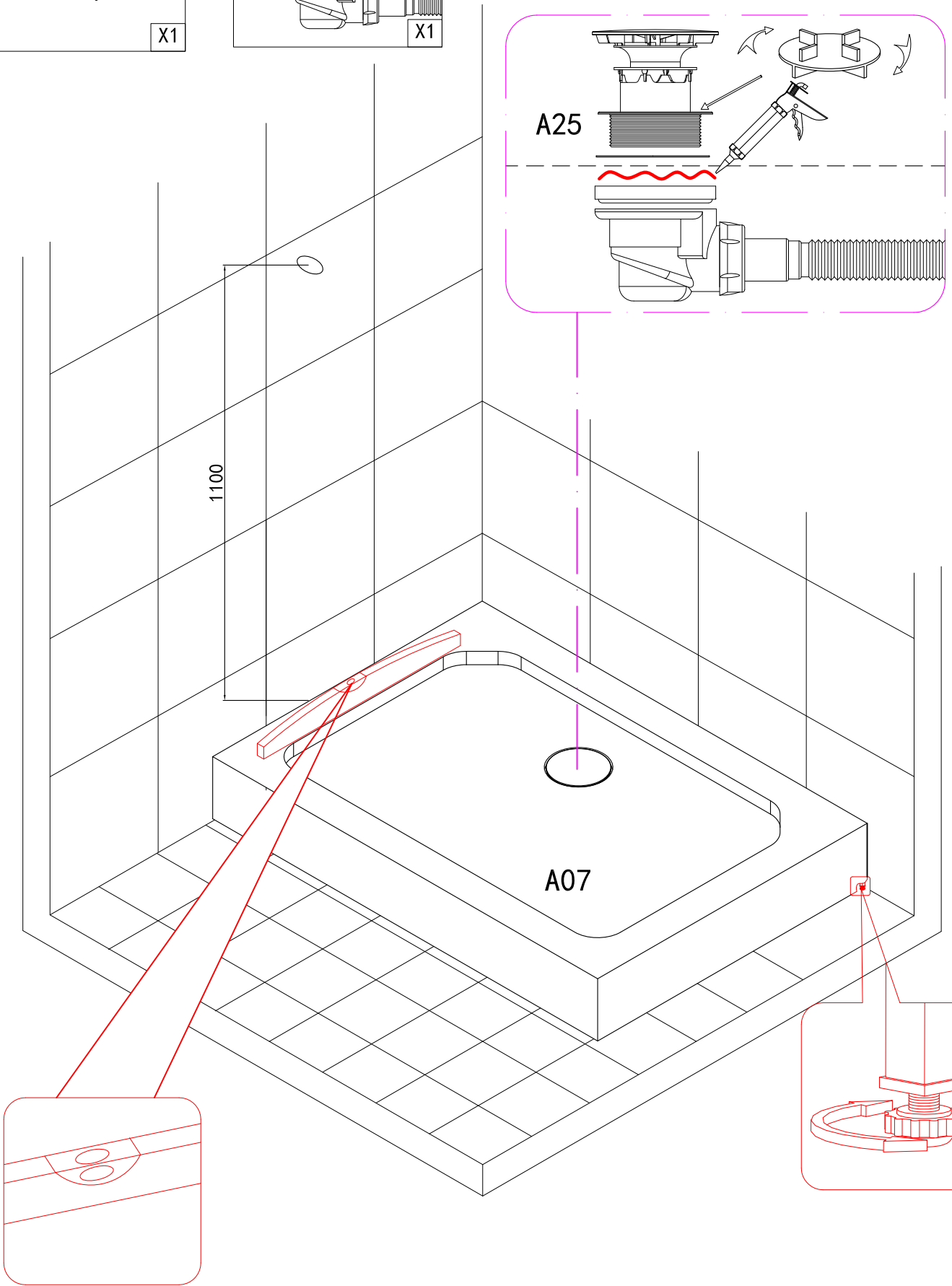
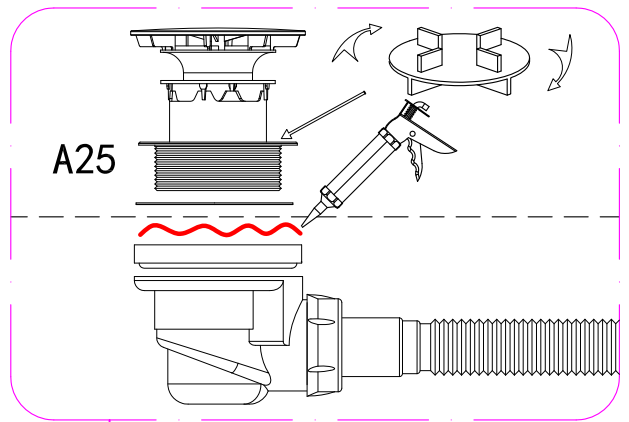
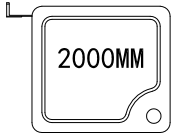
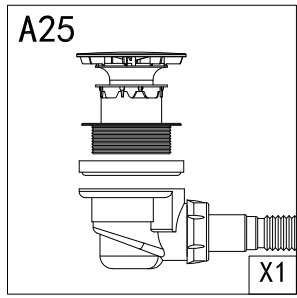
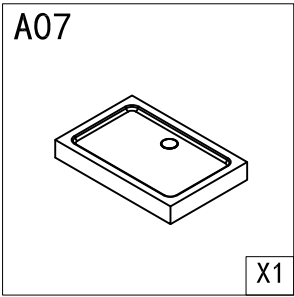

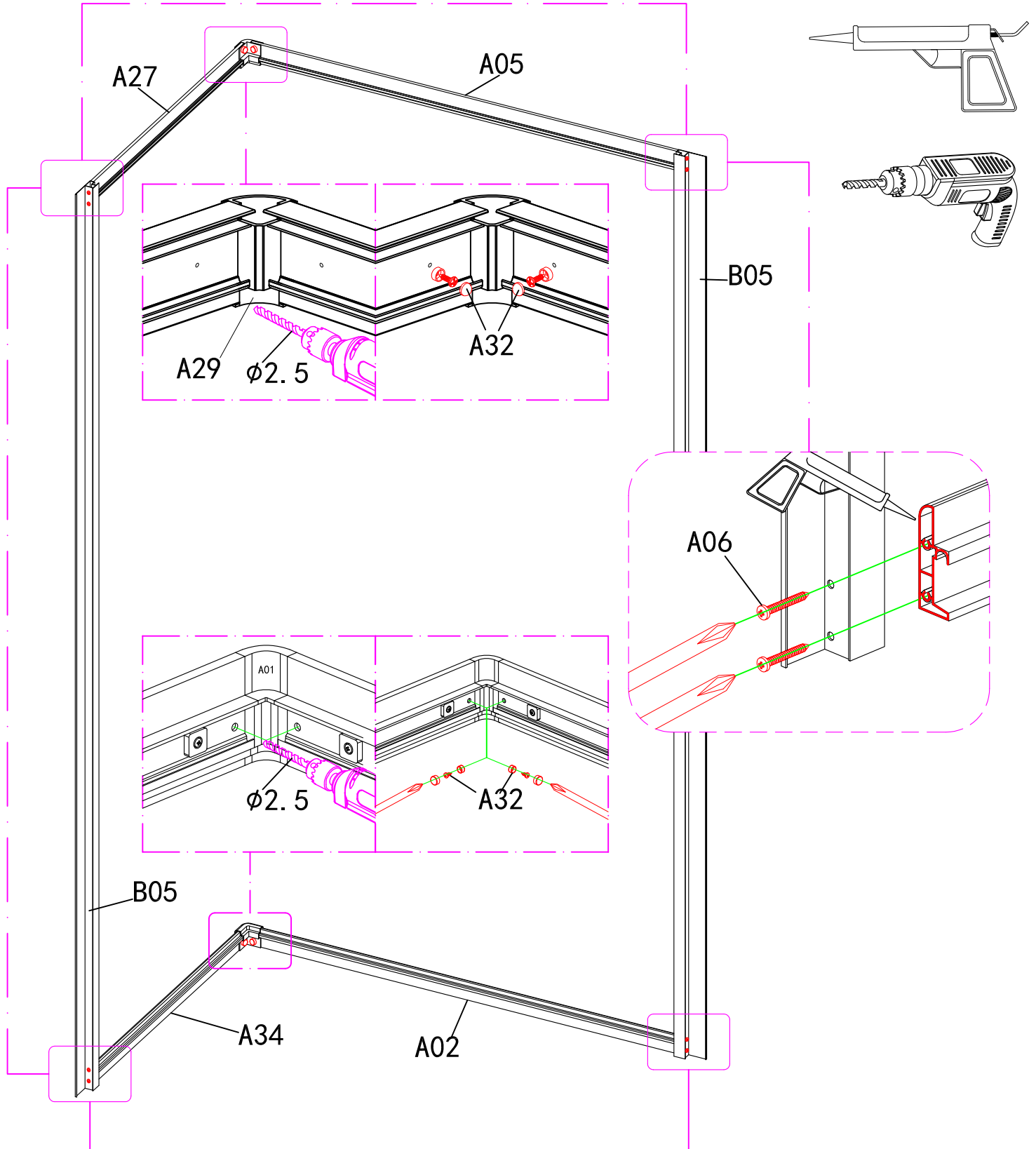
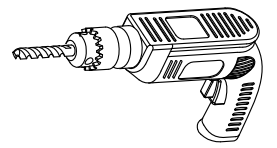
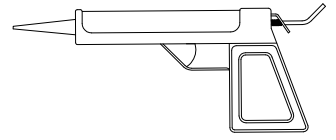
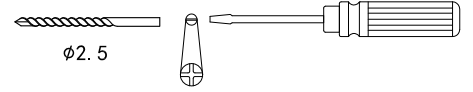
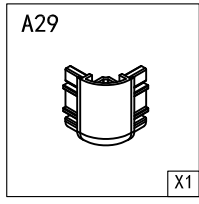
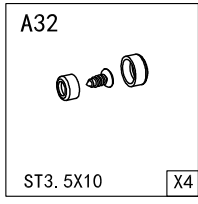
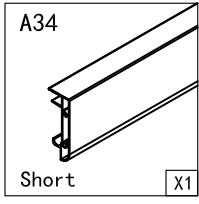
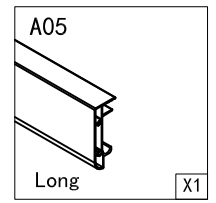
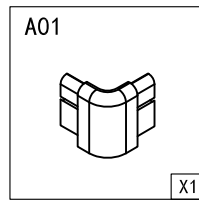
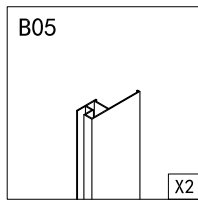
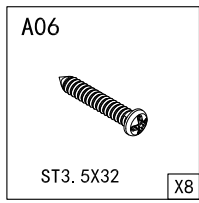
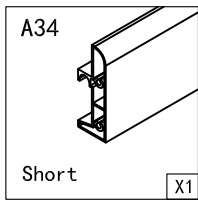
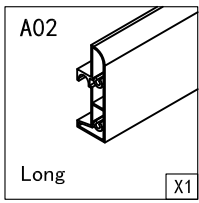

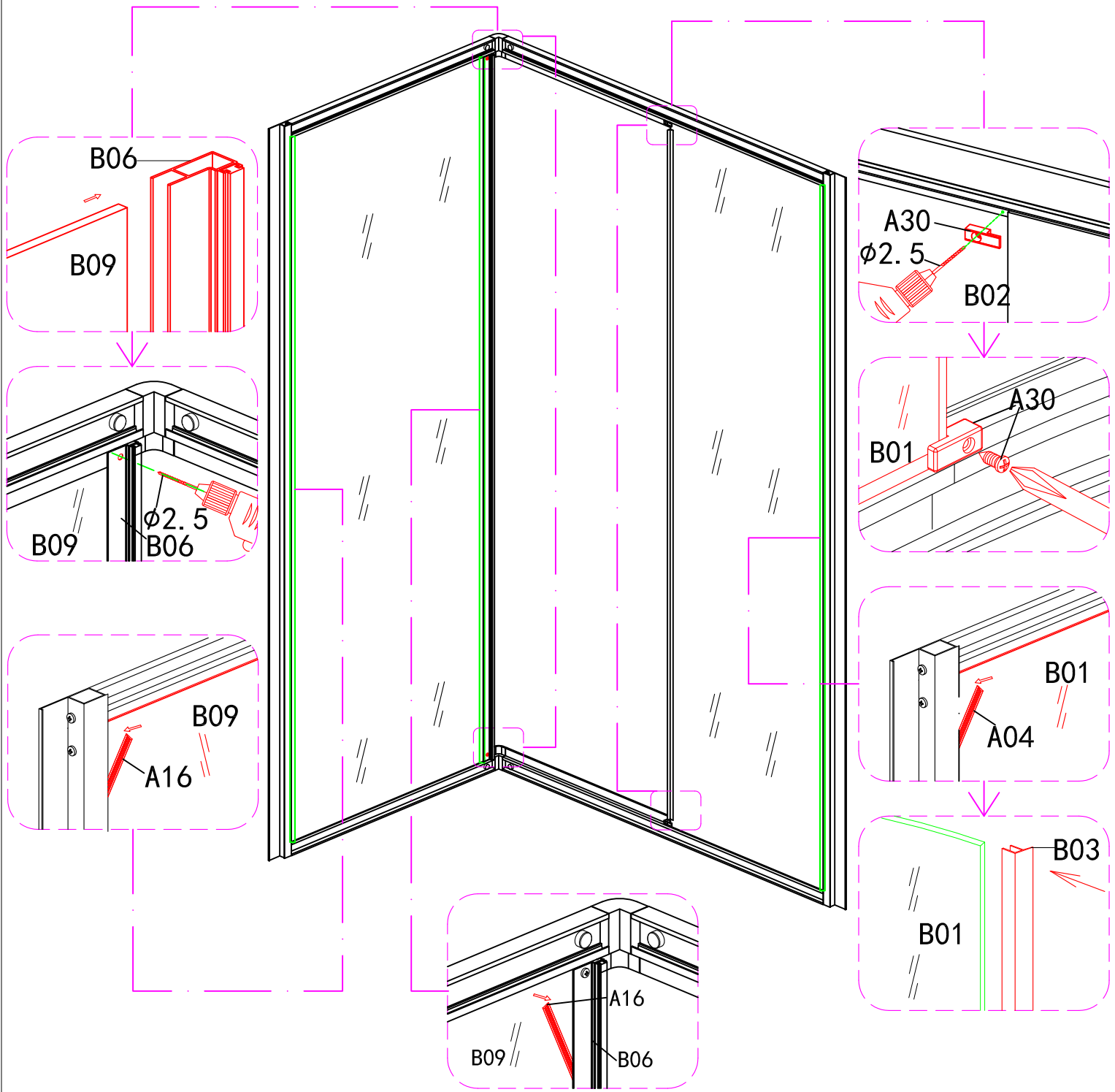
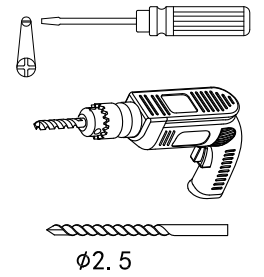
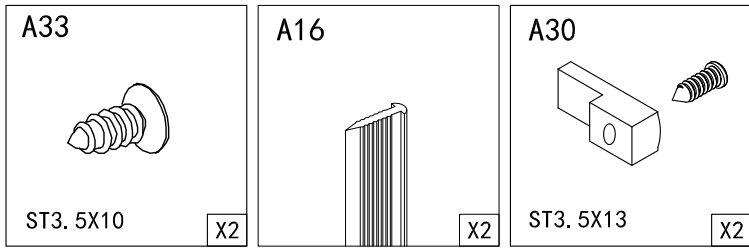
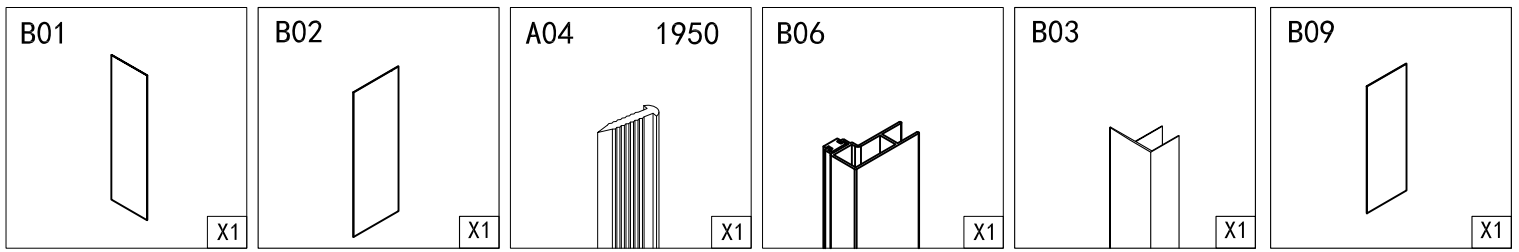

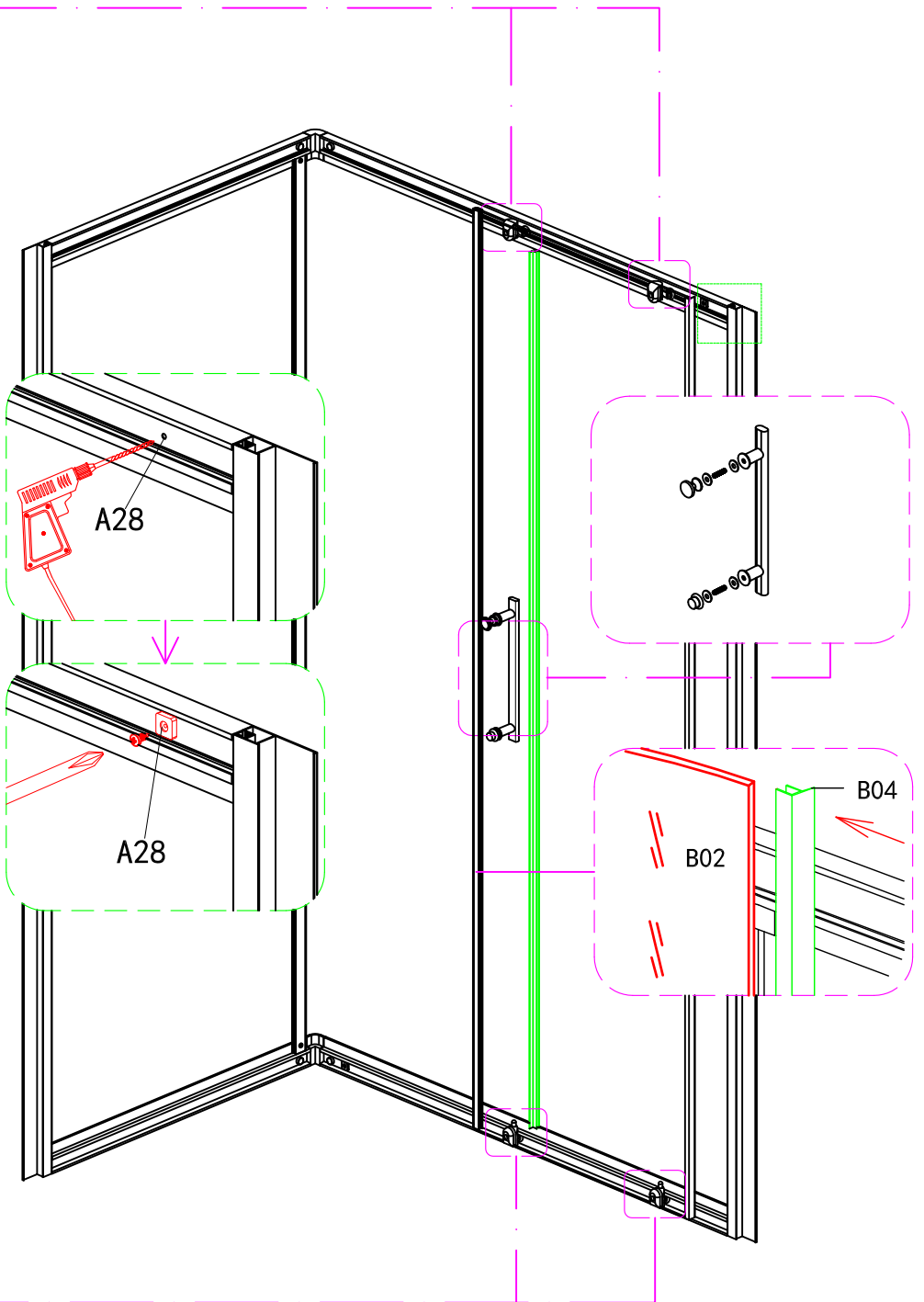
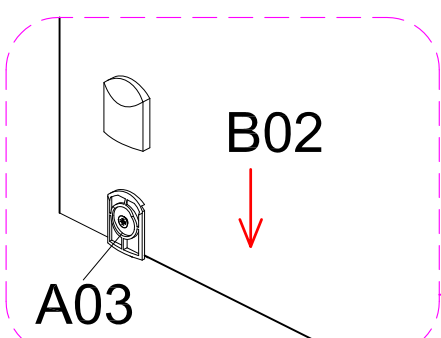
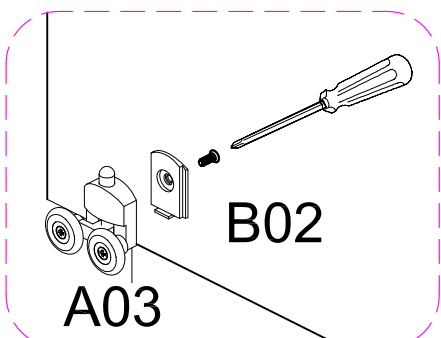
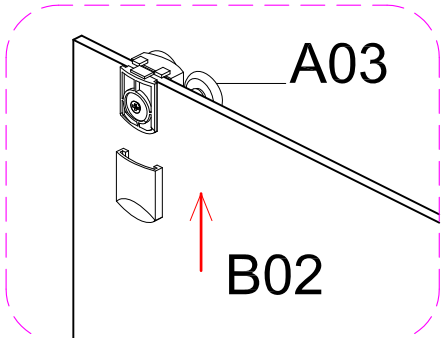
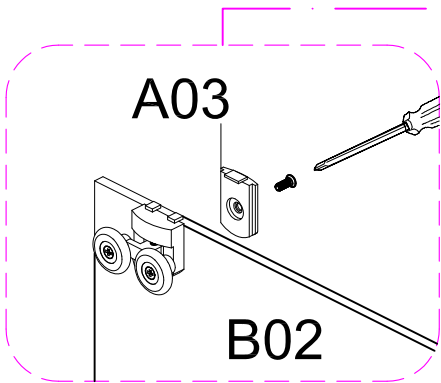
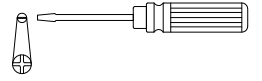
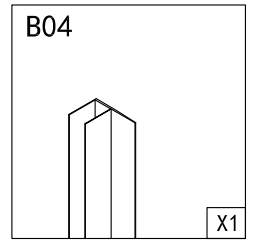
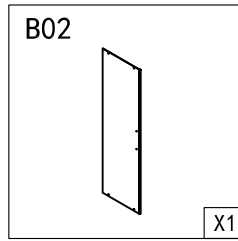
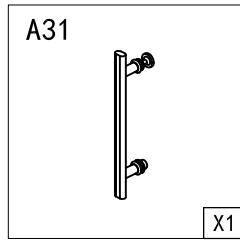
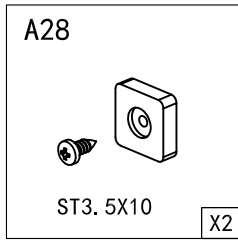
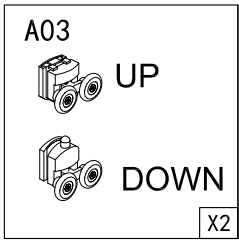

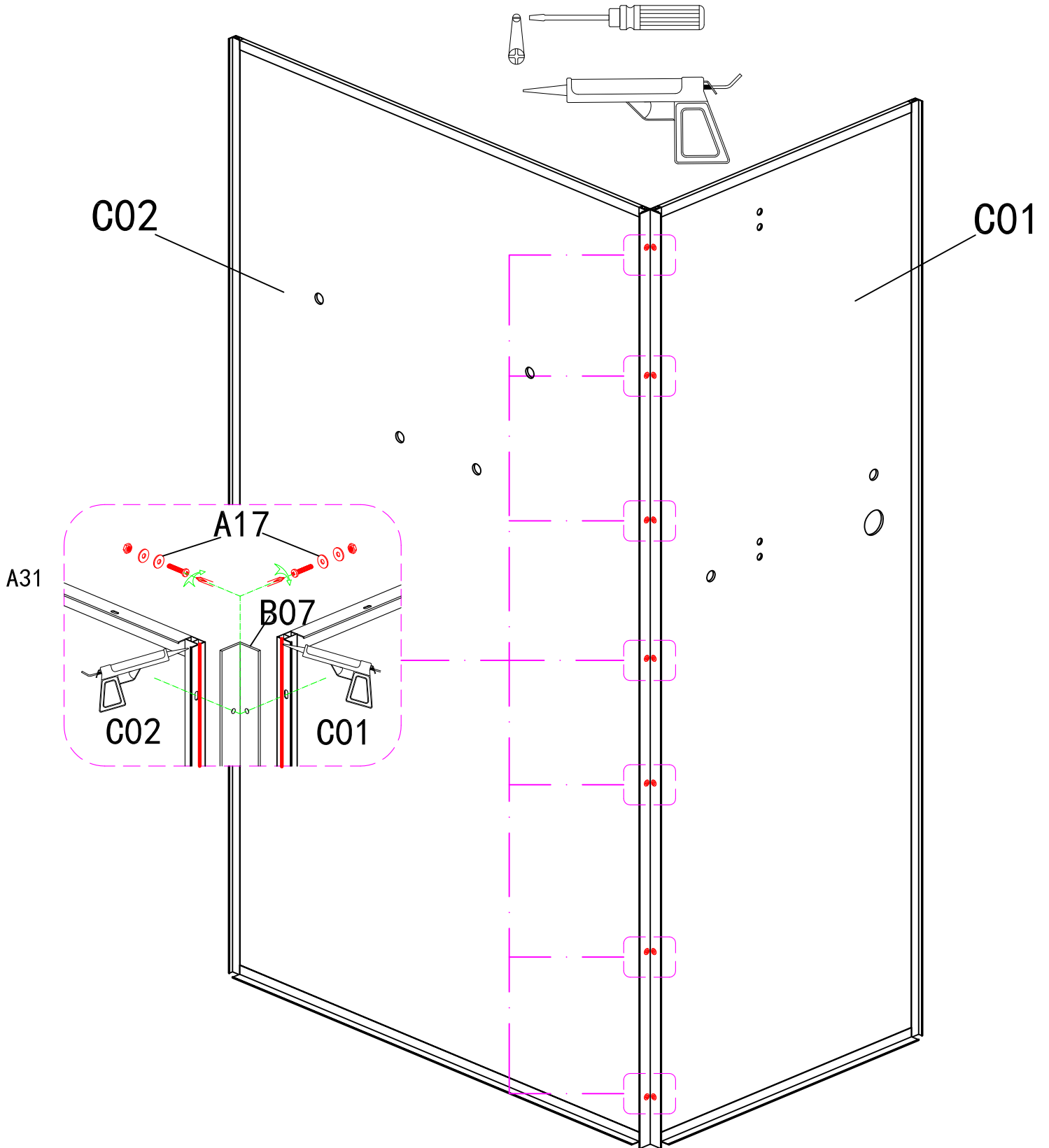
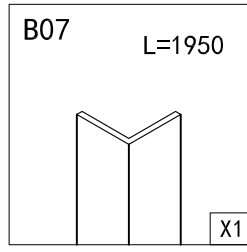
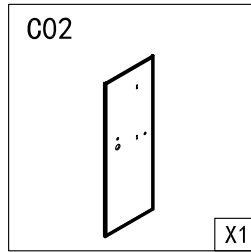
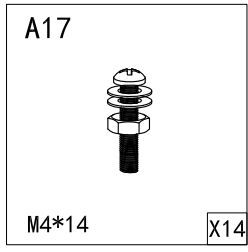
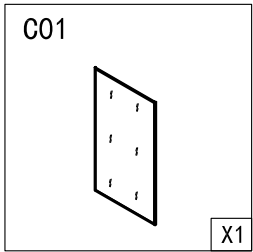



A08

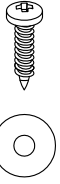

ST3. 5X13

X14

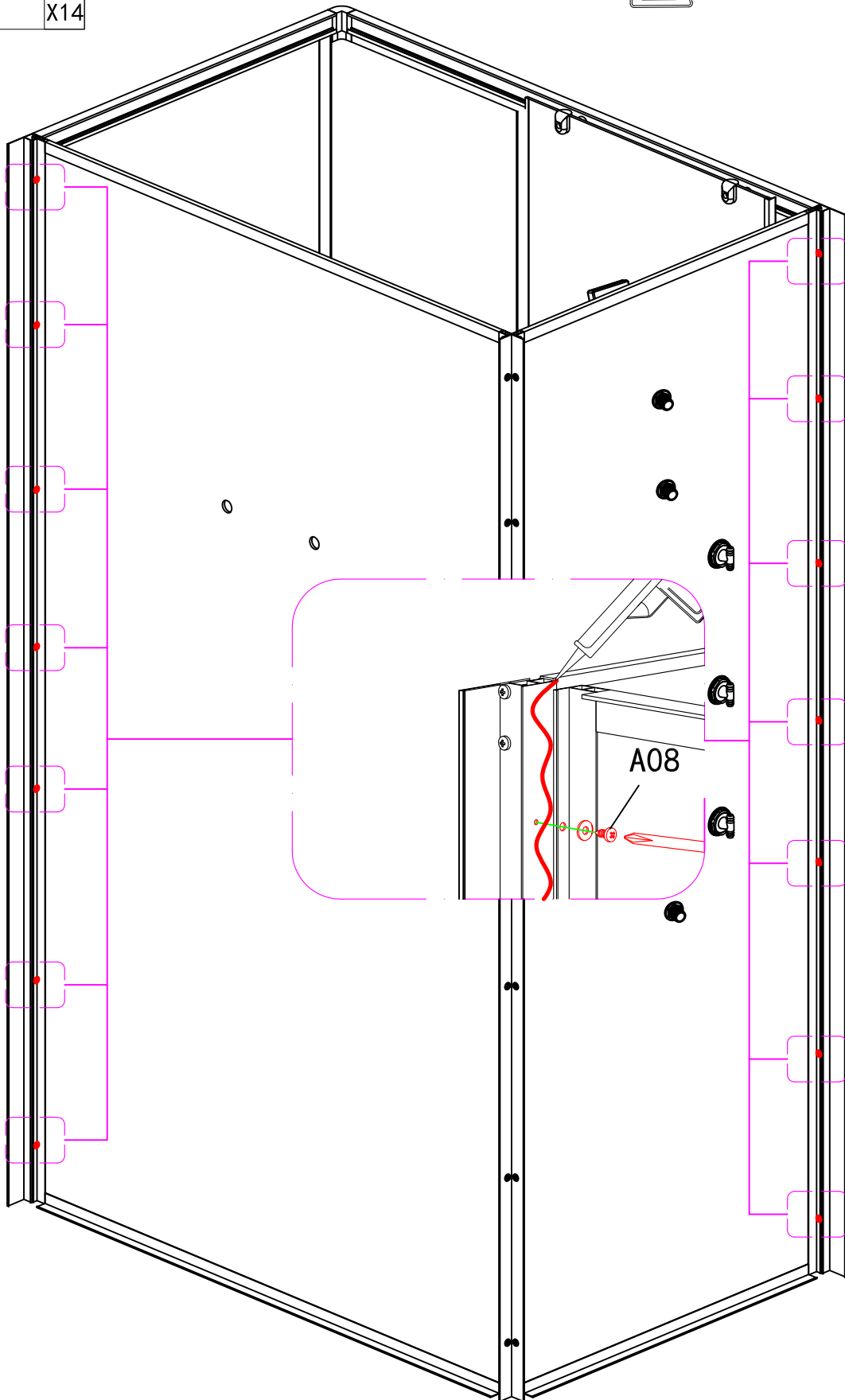
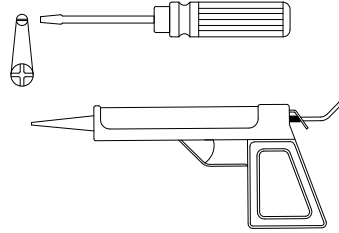

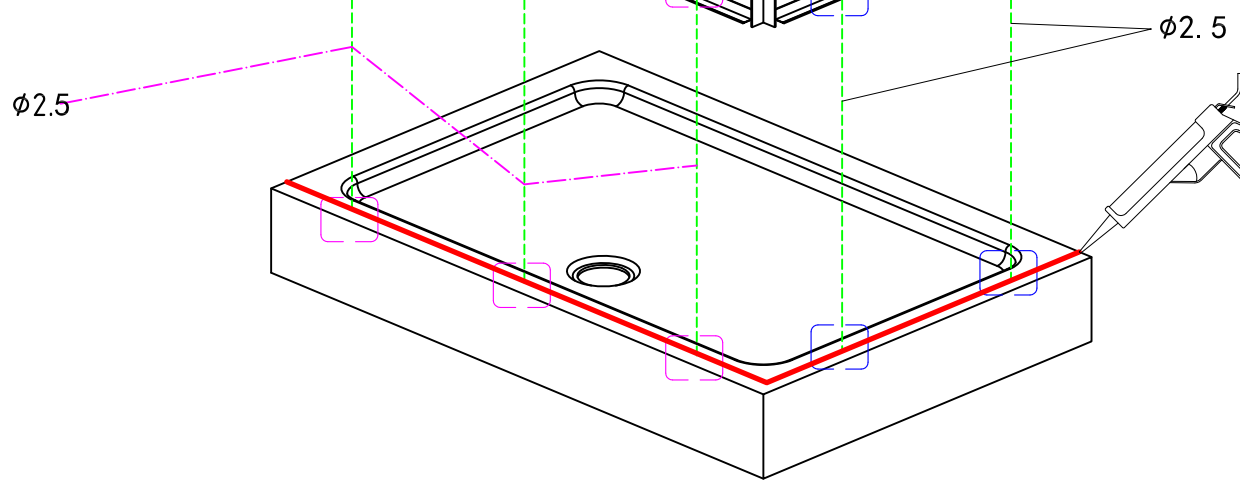
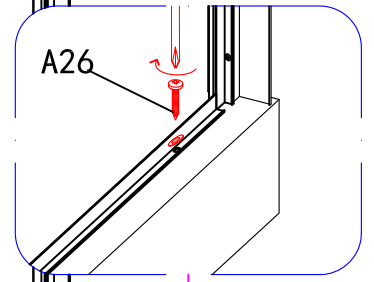
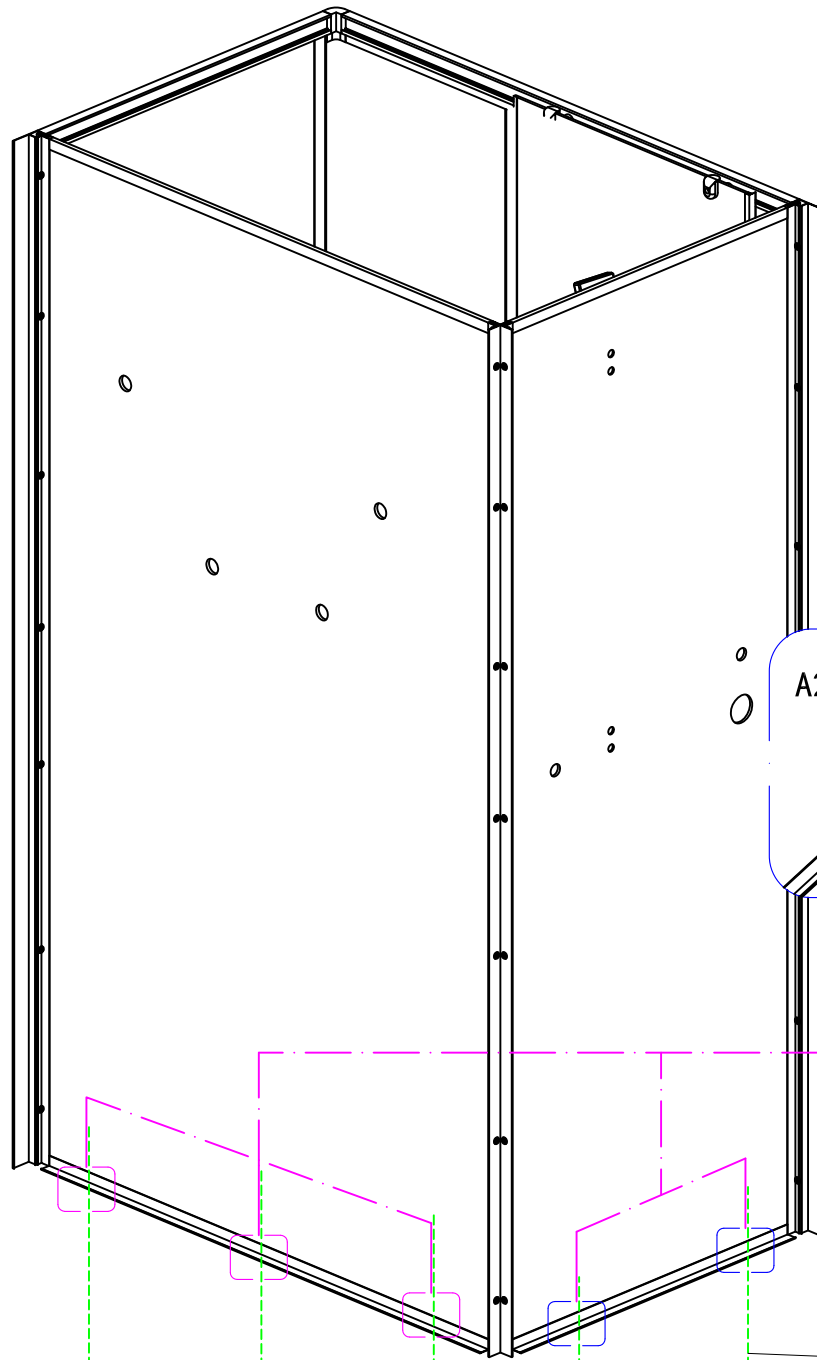
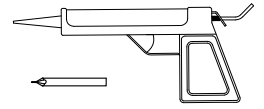
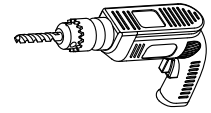
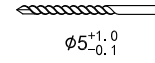
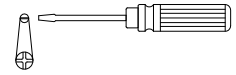
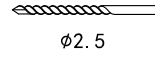
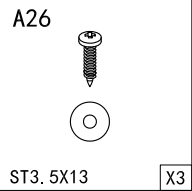

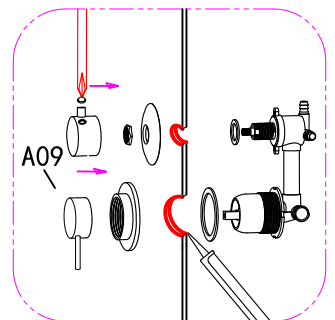
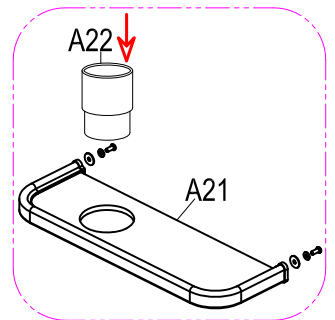
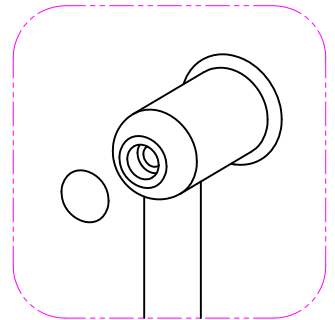
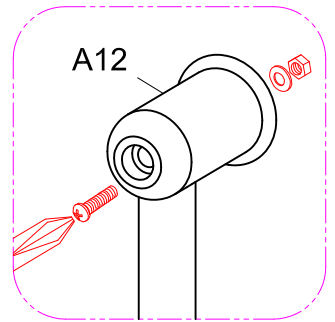
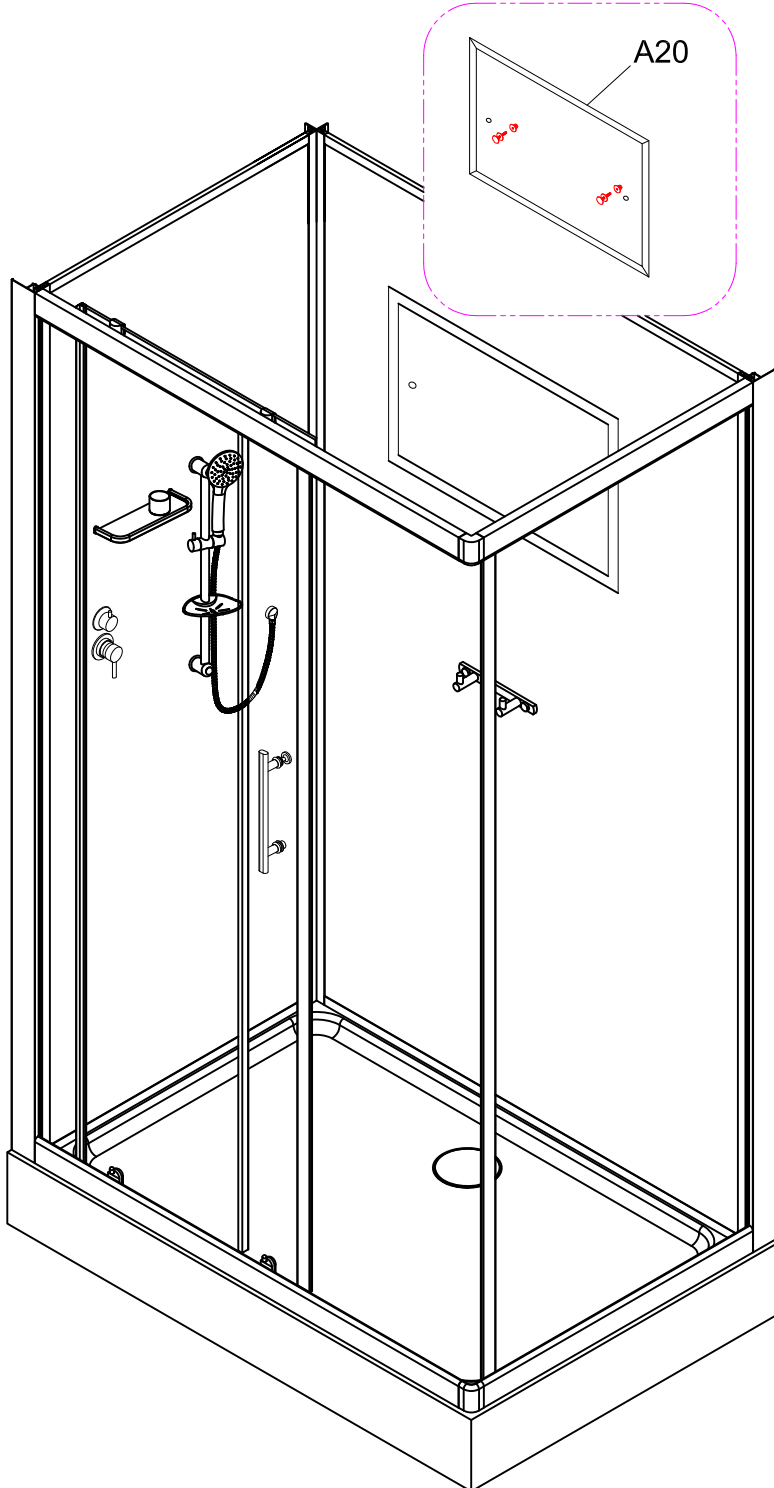
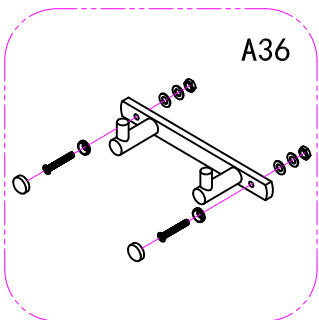
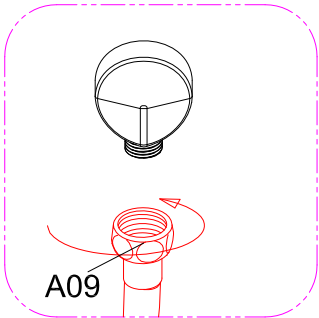
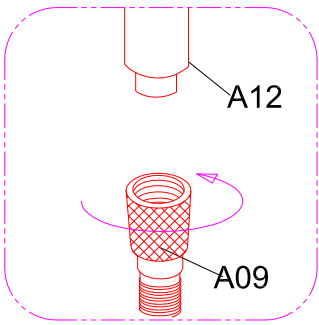
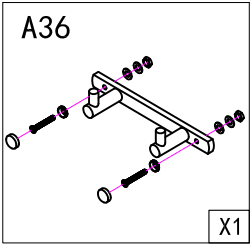
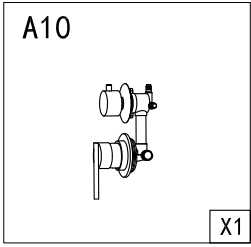
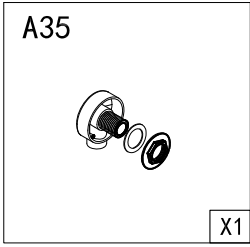
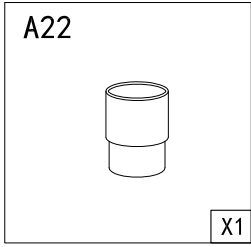
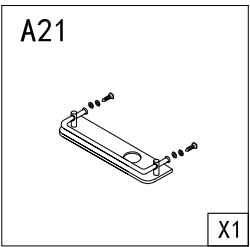
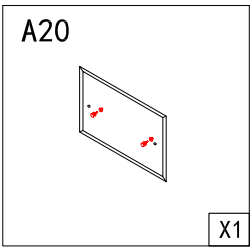
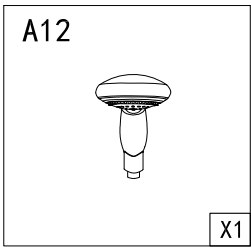
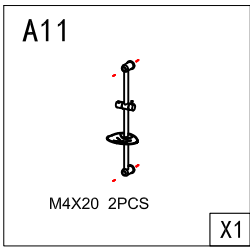
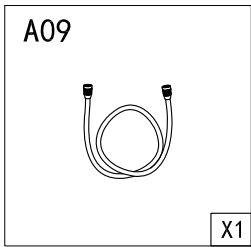

A14

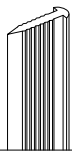

X1

A15



X2

A18



X2

A19



X4

A24



X1

B08

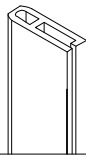

X1

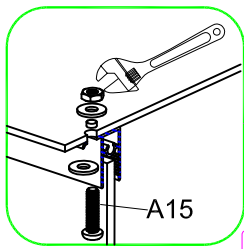

A15

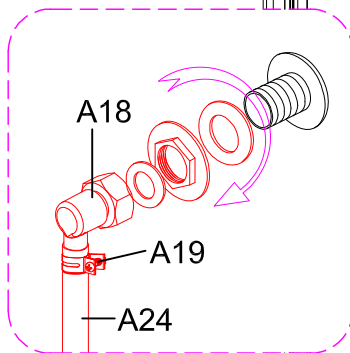
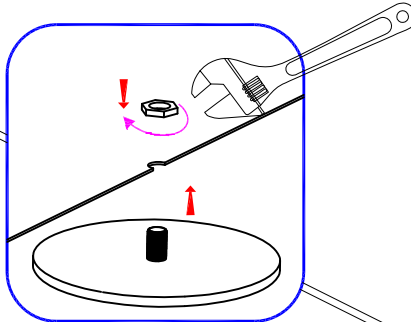

A18

A19

A24

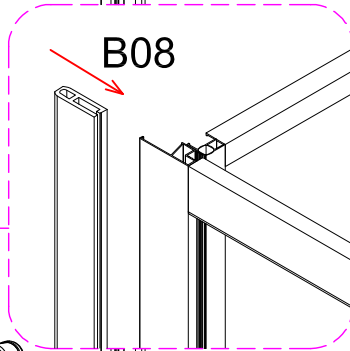

B08

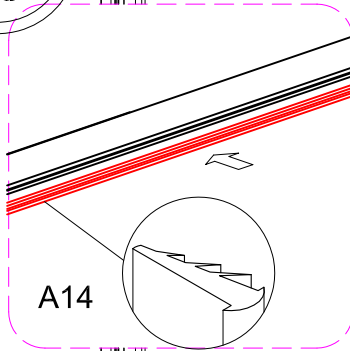

A14

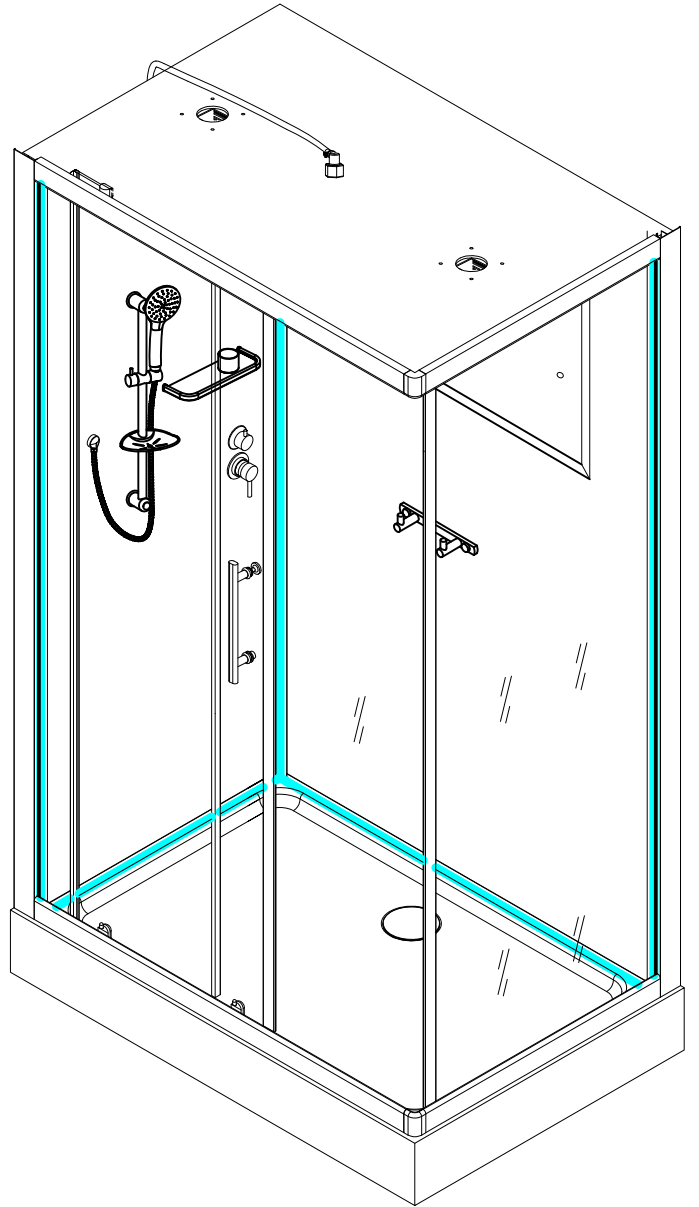
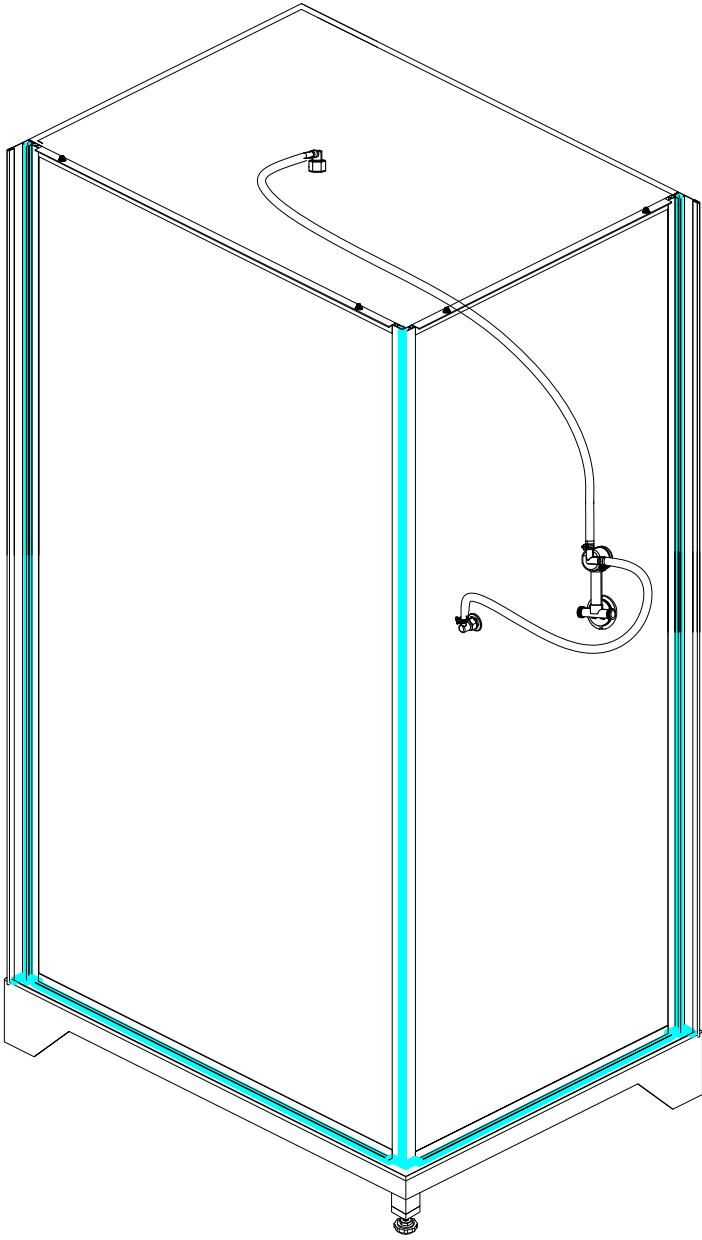
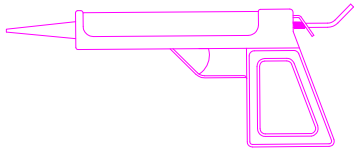

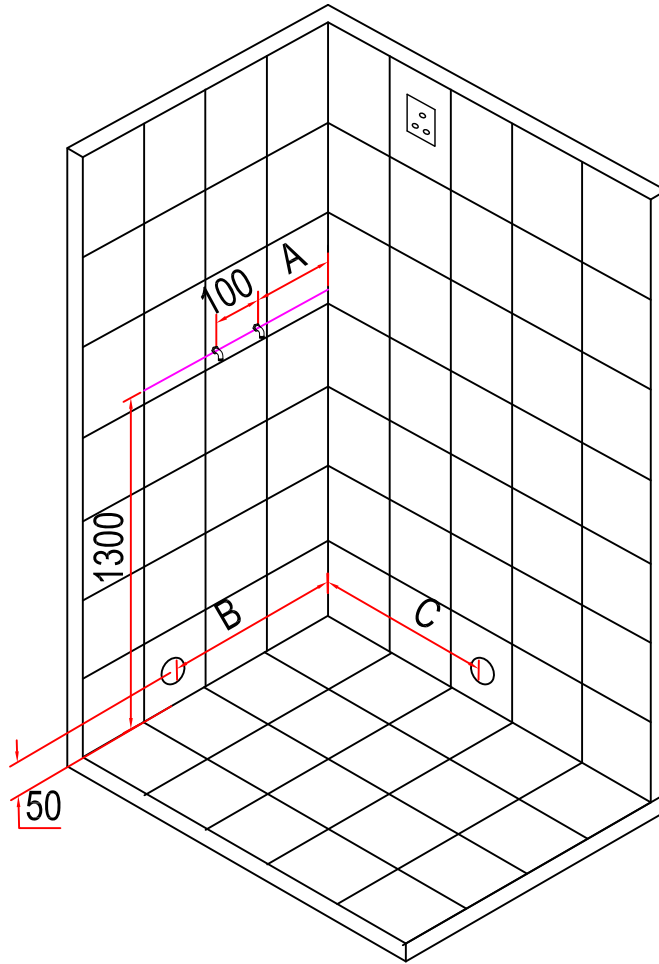
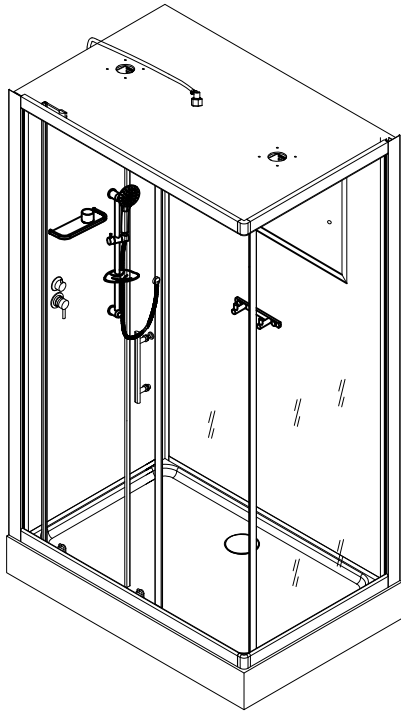

ESW-108CKR

A=350

B=500

C=700

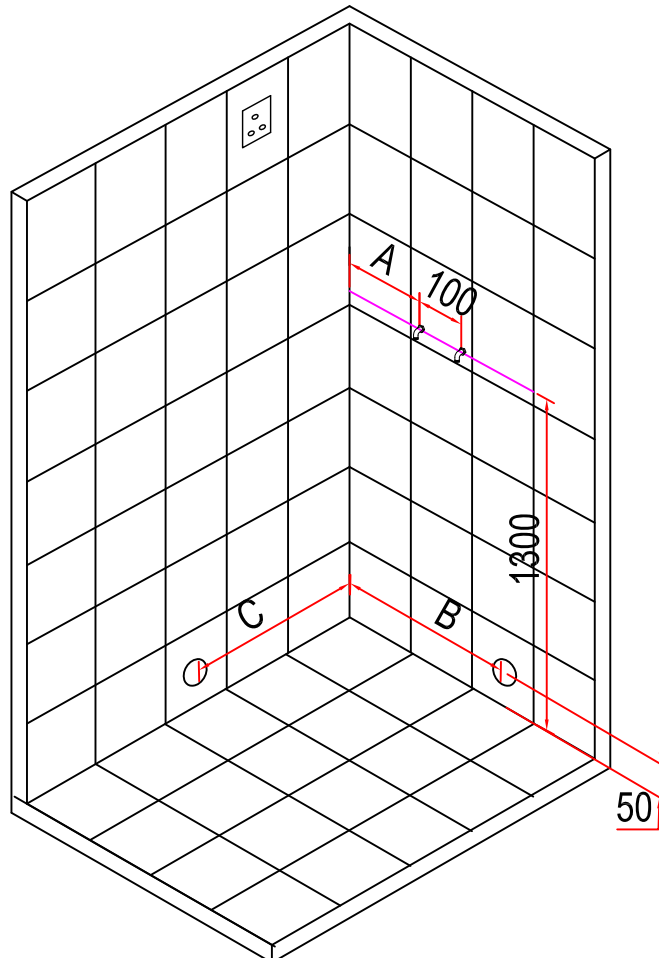
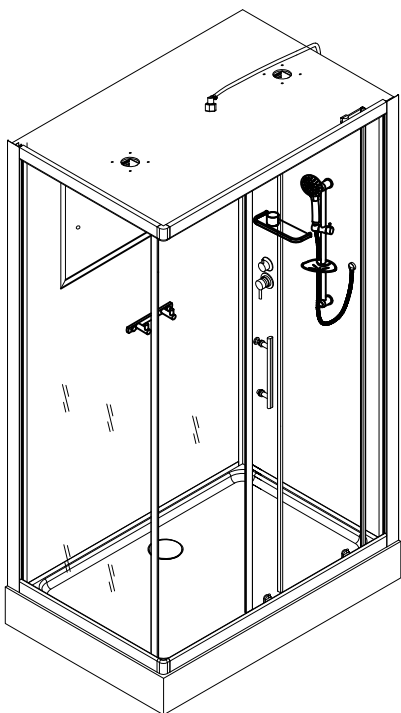

ESW-108CKR

A=350

B=500

C=700